



Swing Gate Opener User's Manual

Model:

KNL1201 (Single Gate)

KNL1202 (Dual Gate)

- ★ Please read and follow all warnings, precautions and instructions before installation and use.
- ★ Never connect the solar panel to the control board directly to charge the battery.
- ★ Periodic checks of the opener are required to ensure safe operation.
- ★ Save this manual.
- ⚠ Please note, if the installation manual is not followed, any problem caused by improper installation or use will not be covered by warranty.



EN27983

Table of Contents

Safety Installation Information.....	1
KNL1201 Parts List	2
KNL1202 Parts List	3
Optional Accessories Parts List.....	4
Tools Needed:	4
Technical Specifications & Features	5
Installation Overview	6
Preparation for Installation	7
Install the Gate Opener on the Gate	7
Mounting the Control Box.....	11
Connection of the Power Supply.....	12
Connecting of the Control Board.....	14
How to Program or Erase the Remote.....	16
How to Use the Remote to Operate Your Gate Opener	17
Wireless Keypad Programming.....	17
Setting of the Control Board.....	18
Indicate Illustration on the Digital Display When Gate Opener is Running	21
Adjusting the Limit Switch	21
Maintenance.....	21
Trouble Shooting	22
Quick-Setting Guide	23

Safety Installation Information

1. READ and FOLLOW all instruction.
2. The gate opener is intended for use with Class I vehicular swing gates.

Class I denotes a vehicular gate opener (or system) dwellings, or a garage or parking area associated therewith.

Install the gate opener only when the opener is appropriate for the construction and the usage class of the gate.

3. Gate opening system designers, installers and users must take into account the possible hazards associated with each individual application. Improperly designed, installed or maintained systems can create risks for the user as well as the bystander. Gate system design and installation must reduce public exposure to potential hazards. All exposed pinch points must be eliminated or guarded.

4. A gate opener can create high levels of force during normal operation. Therefore, safety features must be incorporated into every installation. Specific safety features include safety sensors.

5. The gate must be properly installed and work freely in both directions prior to the installation of the gate opener.

6. The gate must be installed in a location so that enough clearance is provided between the gate and adjacent structure when opening and closing to reduce the risk of entrapment. Swinging gates shall not open into public access areas.

7. The opener is intended for use only on gates used for vehicles. Pedestrians must be supplied with a separate access opening. The pedestrian access opening shall be designed to promote pedestrian usage. The pedestrian access shall be located such that persons will not come in contact with the moving vehicular gate.

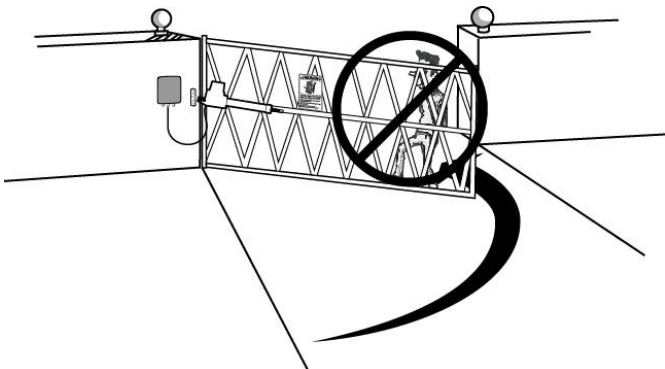

8. Pedestrians should never cross the pathway of a moving gate. The gate opener is not acceptable for use

on any pedestrian gate. Pedestrians must be supplied with a separate pedestrian access.

9. For an installation utilizing non-contact sensors (safety sensors), see product manual on the placement of non-contact sensors (safety sensors) for each type of application.

a. Care shall be exercised to reduce the risk of nuisance tripping, such as when a vehicle trips the safety sensor while the gate is still moving.

b. One or more non-contact sensors (safety sensors) shall be located where the risk of entrapment of obstruction exists, such as the perimeter reachable by a moving gate or barrier.

10. Never mount any device that operates the gate opener where the user can reach over, under, around or through the gate to operate the controls. Controls are to be placed at least 6' (1.8m) from any part of the moving gate.

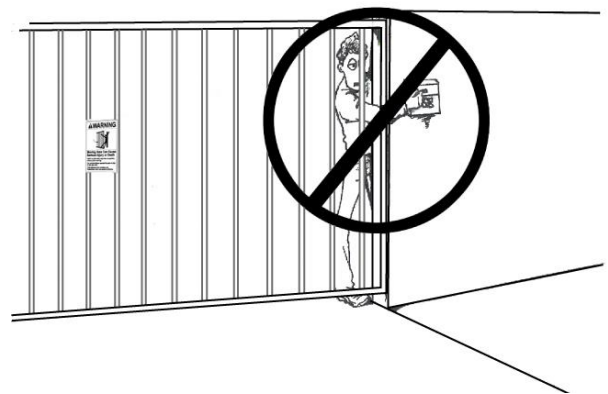

11. Controls intended to be used to reset an operator after 2 sequential activations of the entrapment protection device or devices must be located in the line of sight of the gate, or easily accessible controls shall have a security feature to prevent unauthorized use. Never allow anyone to hang on or ride the gate during the entire travel of the gate.

12. Each gate opener is provided with two safety warning placards. The placards are to be installed on the front and back of the gate where they are plainly visible. The placards may be mounted using cable ties through the four holes provided on each placard.

All warning signs and placards must be installed where visible in the area of the gate.

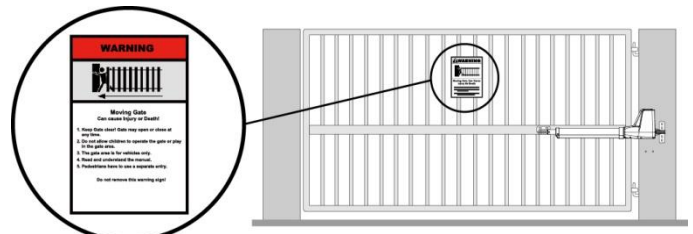









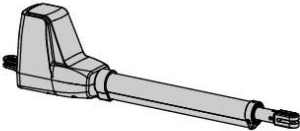











13. To AVOID damaging gas, power, or other underground utility lines, contact underground utility locating companies BEFORE digging.
SAVE INSTRUCTION.





















⚠ WARNING
To prevent SERIOUS INJURY or DEATH from a moving gate:
<ul style="list-style-type: none"> • Install warning signs on the front and back of the gate in PLAIN VIEW. • Permanently secure each warning sign in a suitable manner using fastening holes.

14. Do not permit children to play on or around the gate and keep all controls out of their reach.

KNL1201 Parts List

 Gate Opener Actuator (1 pc)			
 Control Box (1 pc)	 Remote Control (3 pcs)	 Release Key (1 pcs)	 Warning Signs (2 pcs)
 Post Bracket (2 pcs)	 Post Pivot Bracket (1 pcs)	 Gate Bracket (1 pcs)	
Hardware			
 Φ10 Washer (7 pcs)	 M10×200 Bolt (4 pcs)		
 Φ10 Lock Washer (7 pcs)	 M10×75 Bolt (2 pcs)		
 Φ8 Washer (1 pc)	 M10×30 Bolt (1 pc)		
 M10 Nut (7 pcs)	 M8×30 Bolt (1 pc)		
 M8 Nut (1 pc)	 12×40 Clevis Pin (1 pc)		
 Hairpin Clip (2 pcs)	 12×30 Clevis Pin (1 pc)		

KNL1202 Parts List

 <p>Gate Opener Actuator (2 pcs)</p>		
 <p>Control Box (1 pc)</p>	 <p>Remote Control (3 pcs)</p>	 <p>Release Key (2 pcs)</p>
 <p>Post Bracket (4 pcs)</p>	 <p>Post Pivot Bracket (2 pcs)</p>	 <p>Gate Bracket (2 pcs)</p>
 <p>Warning Signs (4 pcs)</p>		
<h2>Hardware</h2>		
 <p>Φ10 Washer (14 pcs)</p>	 <p>M10×200 Bolt (8 pcs)</p>	
 <p>Φ10 Lock Washer (14 pcs)</p>	 <p>M10×75 Bolt (4 pcs)</p>	
 <p>Φ8 Washer (2 pcs)</p>	 <p>M10×30 Bolt (2 pcs)</p>	
 <p>M10 Nut (14 pcs)</p>	 <p>M8×30 Bolt (2 pcs)</p>	
 <p>M8 Nut (2 pcs)</p>	 <p>12×40 Clevis Pin (2 pcs)</p>	
 <p>Hairpin Clip (4 pcs)</p>	 <p>12×30 Clevis Pin (2 pcs)</p>	

Optional Accessories Parts List

Optional			
 Back up battery (1 set) (KNL125)	 Push To Open Bracket (1 pc) (KNL112)	 Wall push button (1 pc) (KNL147)	 Wireless Push Button (1pc) (KNL173)
 Back up battery box(1 pc) (KNL130)	 Alarm Lamp (1 pc) (KNL140)	 Photocell Beam System (1 set) (KNL102)	 External Receiver (KNL138)
 Solar Controller (1 pc) (KNL117 / KNL118)	 Solar panel (1 pc) (KNL109)	 Supporting frame for solar panel (1 pc) (KNL115)	 Bracket for solar panel (1 pc) (KNL116)
 Wireless Keypad (1 pc) (KNL172)	 WiFi Remote Switch (1 pc) (KNL181A)	 Mounting post for keypad (1 pc) (KNL107)	 Reflective Photocell (1 pc) (KNL104A)
 Wired Keypad (1 pc) (KNL174P)	 Wired Keypad (1 pc) (KNL175P)	 Metal Wired Keypad (1 pc) (KNL177)	
 5-core wire (KNL150 Wire A)	 2 x 0.3 sq.mm (KNL151 Wire B)	 2 x 0.75 sq.mm (KNL152 Wire C)	Solar Kit (solar panel, supporting frame, bracket, solar controller, battery x 2, battery box)

Tools Needed:

- Power Drill
- Tape Measure
- Open End Wrenches — 14# & 17# or Adjustable Wrenches
- Wire Strippers
- C-Clamps — small, medium, and large
- Level
- Hacksaw or Heavy Duty Bolt Cutters
- Phillips Screwdriver
- An extra person will be helpful

Technical Specifications & Features

Specifications		
Model:	KNL1201	KNL1202
Input:	120V/60Hz or 220-240V/50Hz	
Motor voltage:	24VDC	
Power:	1×80W	2×80W
Current:	3A	
Actuator speed:	16mm/s (5/8 in/s)	
Max. actuator travel:	385mm (15 1/8 in)	
Ambient Temperature:	-20°C~ +50°C (-4°F to 122°F)	
Protection class:	IP44	

Gate Capacity of KNL1201/1202 for Each Actuator

Gate Weight	600kg	√	NR	NR	NR	NR	NR	NR
	500kg	√	√	NR	NR	NR	NR	NR
	400kg	√	√	√	NR	NR	NR	NR
	300kg	√	√	√	√	NR	NR	NR
	200kg	√	√	√	√	√	NR	NR
	150kg	√	√	√	√	√	√	NR
	100kg	√	√	√	√	√	√	√
		1.2-1.8m	2.4m	3m	3.6m	4.3m	4.8m	5.5m
Gate Length								

Features:

- Soft start and soft stop
- Emergency release key in case of power failure
- Dual/Single gate running mode
- Adjustable opening/closing interval between master and slave gate
- Stop in case of obstruction during gate opening.
- Reverse in case of obstruction during gate closing.
- Built in adjustable auto-close (0-99 seconds)
- Built in max. Motor running time (MRT) adjustable for multiple safety protection (1-50 seconds)
- Digital display indicates the running situation and setting menu
- Reliable electromagnetism limit for easy adjustment
- Can be equipped with a wide range of accessories
- Easy to install, and minimum maintenance requirement

Installation Overview

Pull-to-Open Gates

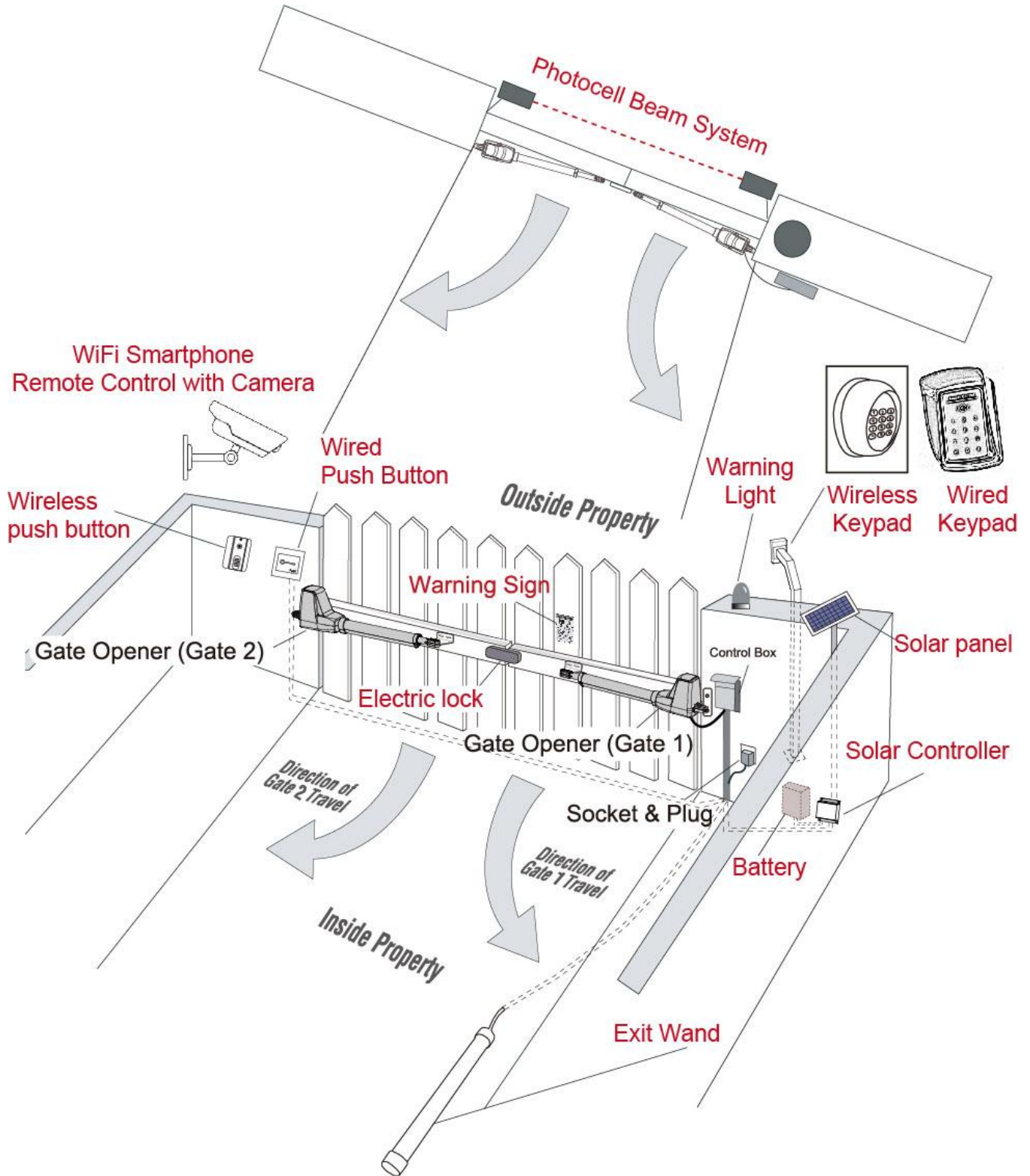

Important:

The second gate opener cable should be put into the PVC conduit (not provided) which is buried underground. This protects the cable from lawn mowers and string trimmers.

★ Please note all the optional accessories are not included, please contact your supplier to purchase.

Preparation for Installation

There are two installation types for the gate opener, **Pull-to-Open** and **Push-to-Open**.

In the **Push-to-Open** installation, gate opens out from the property. A Push-To-Open Bracket (**PSO part**) is required to be used for each gate.

NOTE: Ensure the gate does not open into public areas.

The gate opener is mounted to the gate and to the gate post. Both round and square posts can be used because the Post Brackets are curved. When mounting the Post Brackets, use bolts long enough to pass through the entire post. M10 x 200 bolts are included. Concrete anchors are not provided.

When mounting the Post Brackets to wooden posts, a larger-size washer or metal plate should be used between the bolts and the wooden post to ensure the stability of the fastening hardware. If the post is smaller than 6" diameter or square, it should be made of metal and set in cement to ensure its stability.

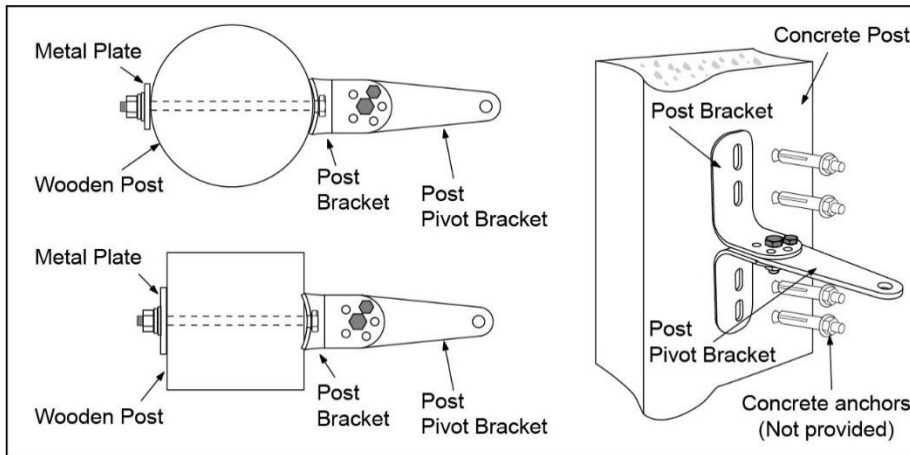

Install the Gate Opener on the Gate

The position of Post Bracket is very important. The following illustrations and tables are required to determine the proper mounting position for the Post Bracket. The tables show the maximum opening angle of the gate for a given A and B. For example, if A is 15cm and B is 20cm, the maximum opening angle of the gate is 110°.

Pull-to-Open Installation — Gate in Closed position (Moving-Rod is extended)

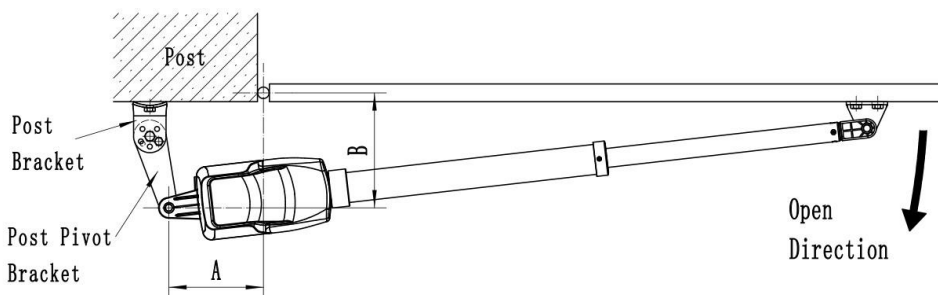

	A=9cm	A=10cm	A=11cm	A=12cm	A=13cm	A=14cm	A=15cm	A=16cm	A=17cm	A=18cm	A=19cm	A=20cm
B=19cm	92°	91°	93°	96°	99°	101°	103°	105°	100°	97°	93°	90°
B=20cm	92°	90°	93°	95°	98°	102°	105°	99°	94°	91°	89°	
B=21cm	92°	90°	92°	95°	98°	101°	98°	94°	91°	88°		
B=22cm	93°	90°	92°	94°	96°	98°	93°	90°	87°			
B=23cm	93°	91°	93°	95°	98°	93°	90°	87°				
B=24cm	91°	90°	92°	94°	92°	88°	86°					
B=25cm	91°	90°	92°	91°	87°	85°						
B=26cm	91°	90°	90°	86°								
B=27cm	91°	90°	85°									
B=28cm	91°	84°										

Push-to-Open Installation — Gate in Closed position (Moving-Rod is retracted)

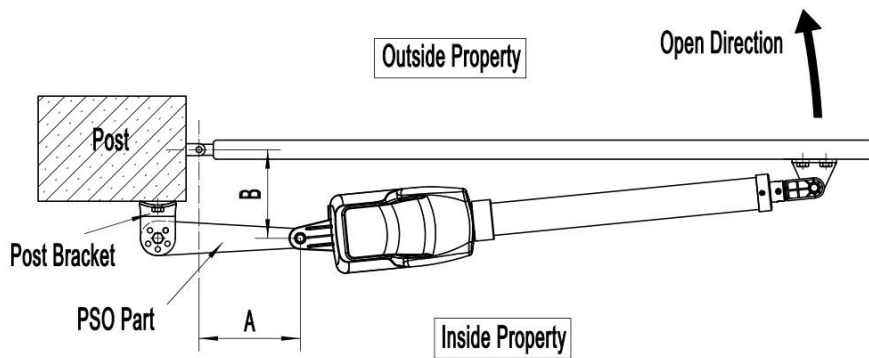

	A=12cm	A=14cm	A=16cm	A=18cm	A=20cm	A=22cm	A=24cm
B=9cm	95°	106°	115°	120°	112°	103°	94°
B=11cm	93°	102°	110°	115°	106°	95°	90°
B=13cm	92°	99°	105°	109°	99°	90°	83°
B=15cm	93°	100°	107°	104°	92°	84°	
B=17cm	91°	96°	103°	96°	86°		
B=19cm	90°	95°	101°	88°			
B=21cm	90°	94°	92°				
B=23cm	90°	92°	85°				
B=25cm	90°	89°					
B=27cm	87°						

1. Insert the M10 x 30 bolt through the center hole of the post bracket and post pivot bracket as shown. Place a ϕ 10 washer, ϕ 10 lock washer and M10 nut on the bottom of the bolt and hand tighten.

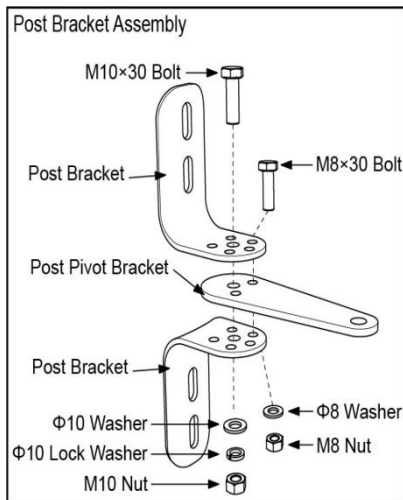

2. Attach the gate bracket and post bracket assembly to the opener by inserting a clevis pin. Secure the clevis pins using the hairpin clips.

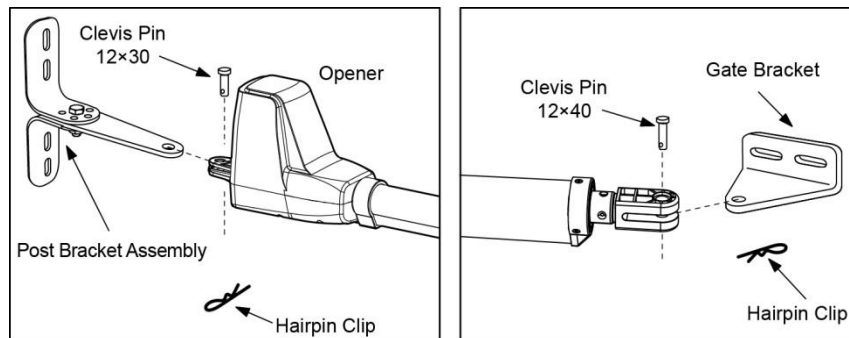

3. Open the release hole plug on the top of the gate opener, insert the release key, and turn the key 90° clockwise. This releases the motor and allows the push-pull rod to be manually extended and retracted. To restore normal operation, turn the key 90° counterclockwise.

4. With the opener fully retracted and with the gate in the fully open position (for Pull-to-Open installation) or fully closed position (for Push-to-Open installation), place the gate opener with the Post Bracket Assembly and Gate Bracket on the gate post and the gate. Position the Post Bracket Assembly and Gate Bracket so that the gate opener is level. While holding the gate opener in the level position, temporarily secure it with two C-clamps.

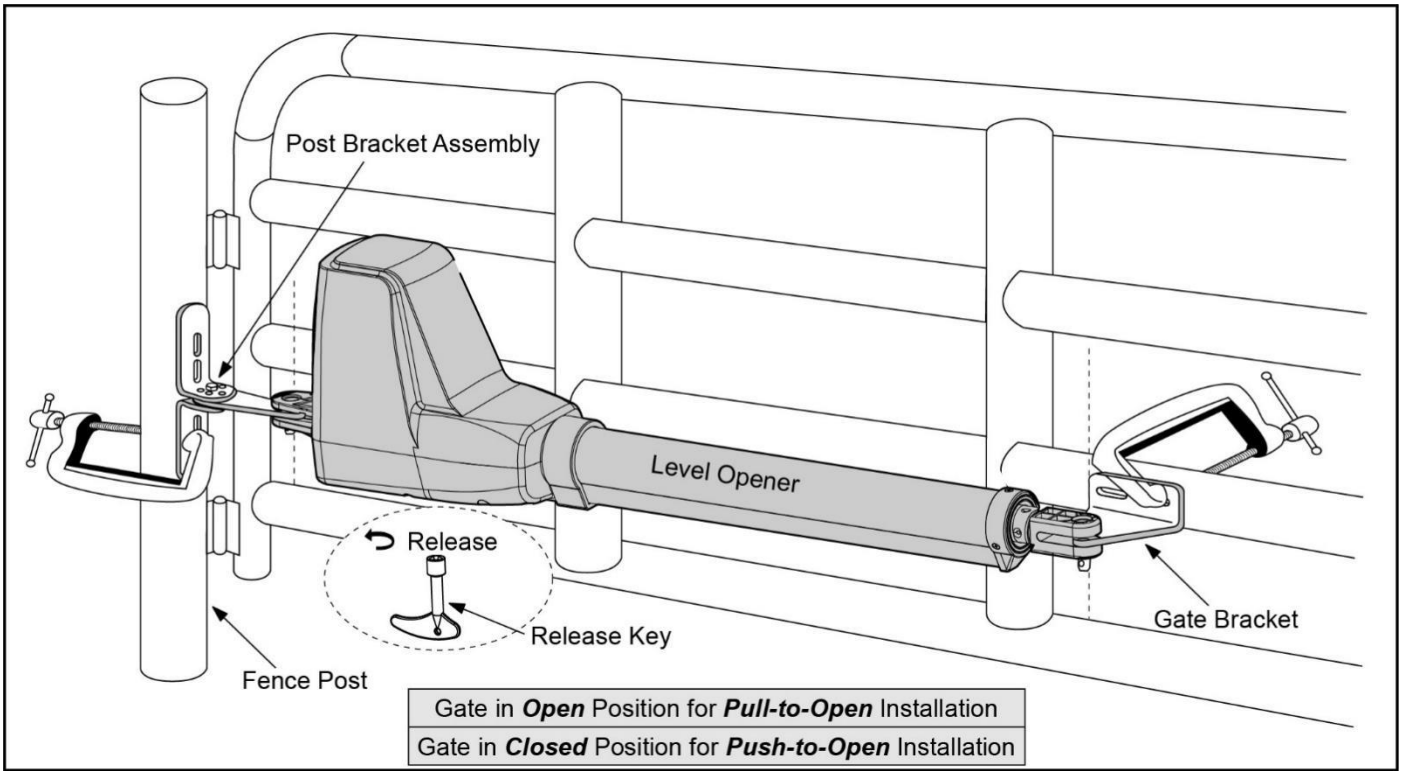

5. Make sure that there is a minimum clearance of 2.5cm between the gate and the opener and that the opener and the Post Pivot Bracket are not binding in both the gate-open and gate-closed positions. If there is not at least 2.5cm of clearance or if the opener and the Post Pivot Bracket are binding, rotate the Post Pivot Bracket and/or move the Post Bracket Assembly to obtain the minimum clearance and eliminate the binding. When the minimum clearance has been obtained and any binding has been eliminated, place the M8 x 30 bolt through the aligned holes in the Post Bracket and the Post Pivot Bracket.

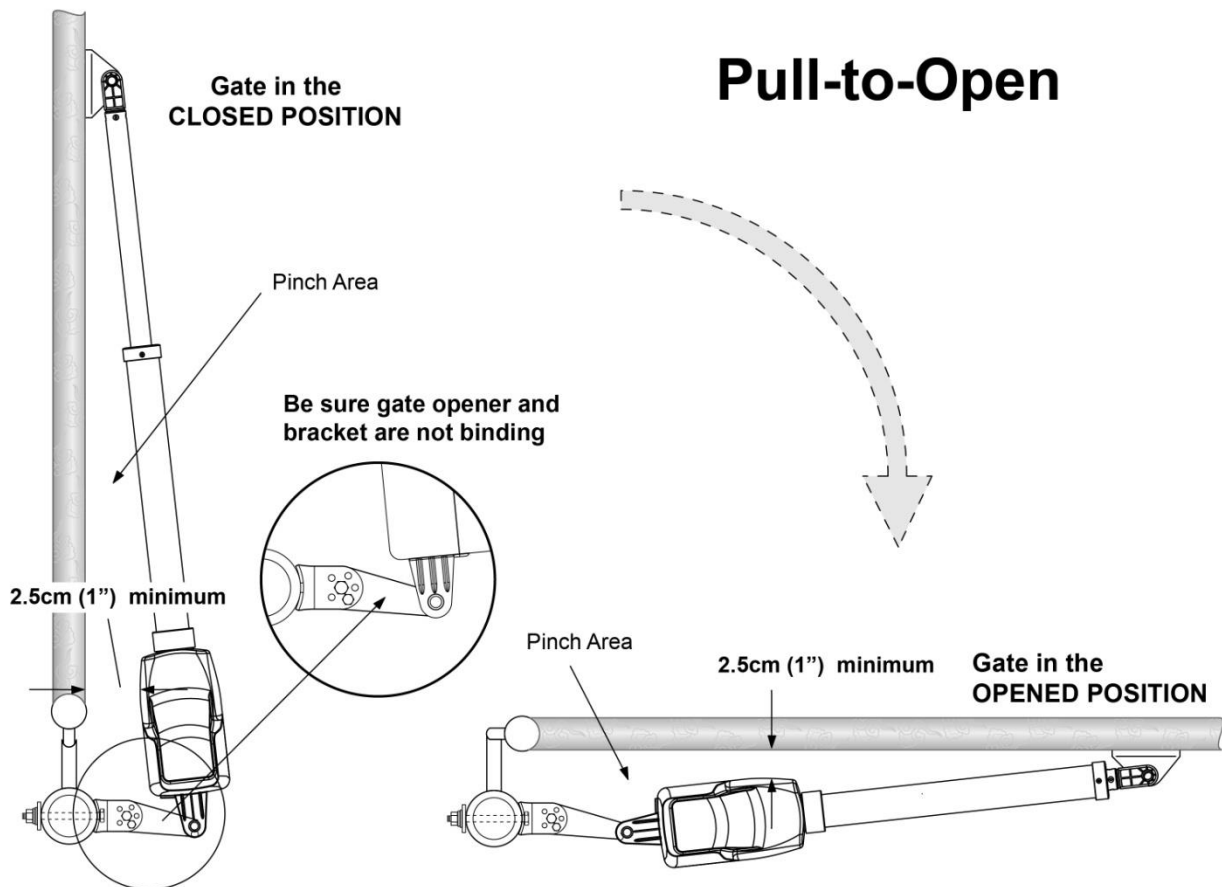

Push-to-Open

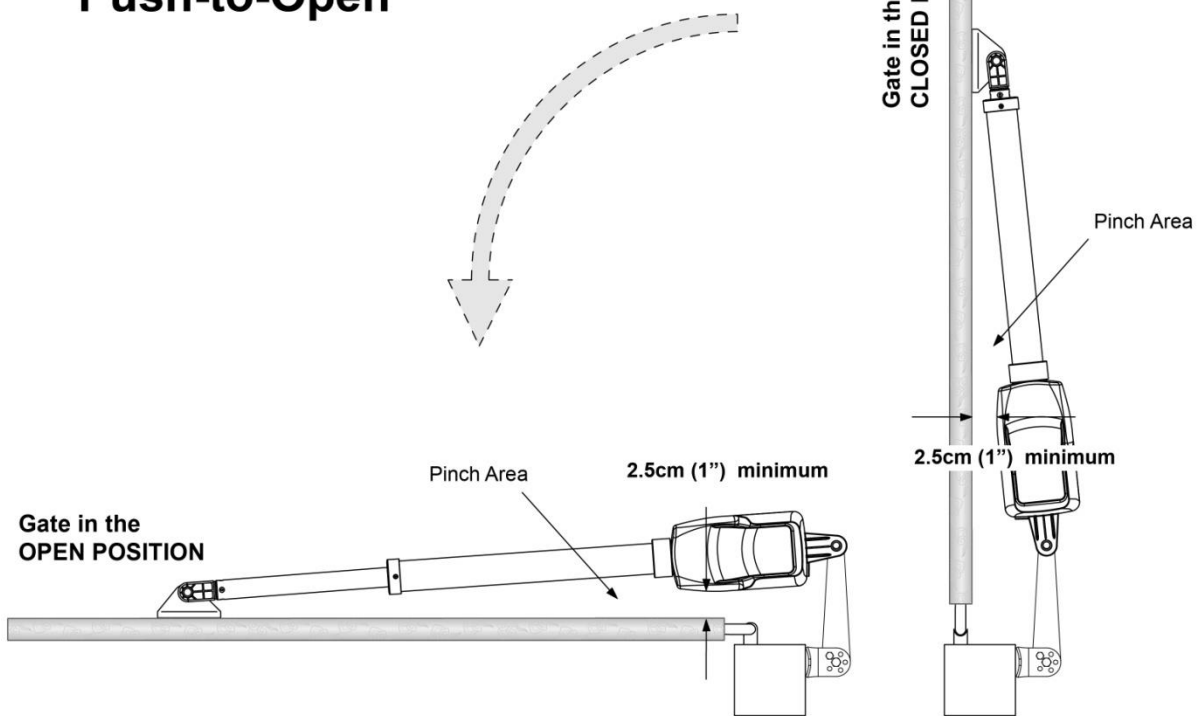

6. Sign the bolt-hole point on the gate bracket and gate. Do this by placing a punch or a sign in the middle of each bolt slot on the post bracket assemblies and the gate bracket. It allows slight adjustments to the post bracket. Then remove the post bracket and gate bracket by taking off the C-clamps.

7. Drill 10.5 mm diameter holes through the post and the gate at the marked locations.

8. Attach the post bracket assemblies to the gate posts by inserting M10 x 200 bolts through each post bracket assembly and the drilled holes in the gate post. Fasten each bolt with one \varnothing 10 washer, one \varnothing 10 lock washer, and one \varnothing 10 nut.

9. Attach the gate brackets to each gate by inserting two M10 x 75 bolts through the gate brackets and the drilled holes in the gates. Fasten each bolt with one \varnothing 10 lock washer, and one \varnothing 10 nut.

10. Cut off any part of the bolts that extend beyond the tightened nuts.

11. With the gate opener fully retracted and with the gate in the fully open position (for Pull-to-Open installation) or fully closed position (for Push-to-Open installation), attach the gate opener to the Post Bracket Assembly and the Gate Bracket by inserting a clevis pin through the gate opener and the Post Pivot Bracket and another clevis pin through the gate opener and the Gate Bracket. Secure each clevis pin with a hairpin clip.

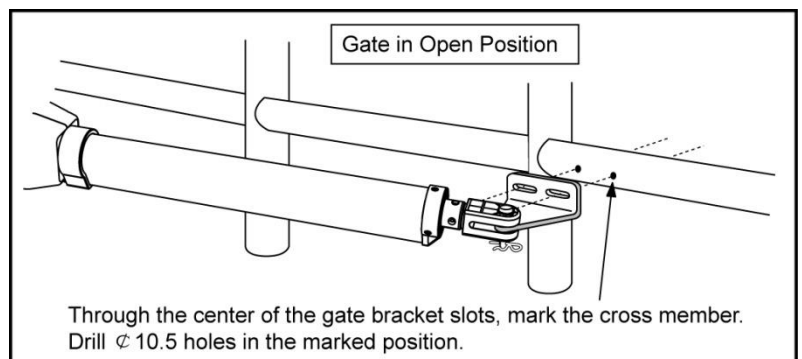
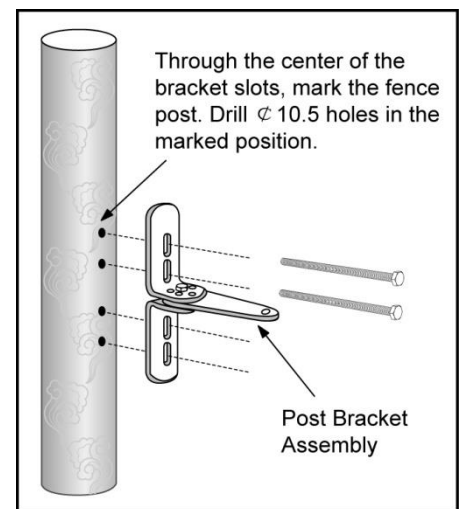

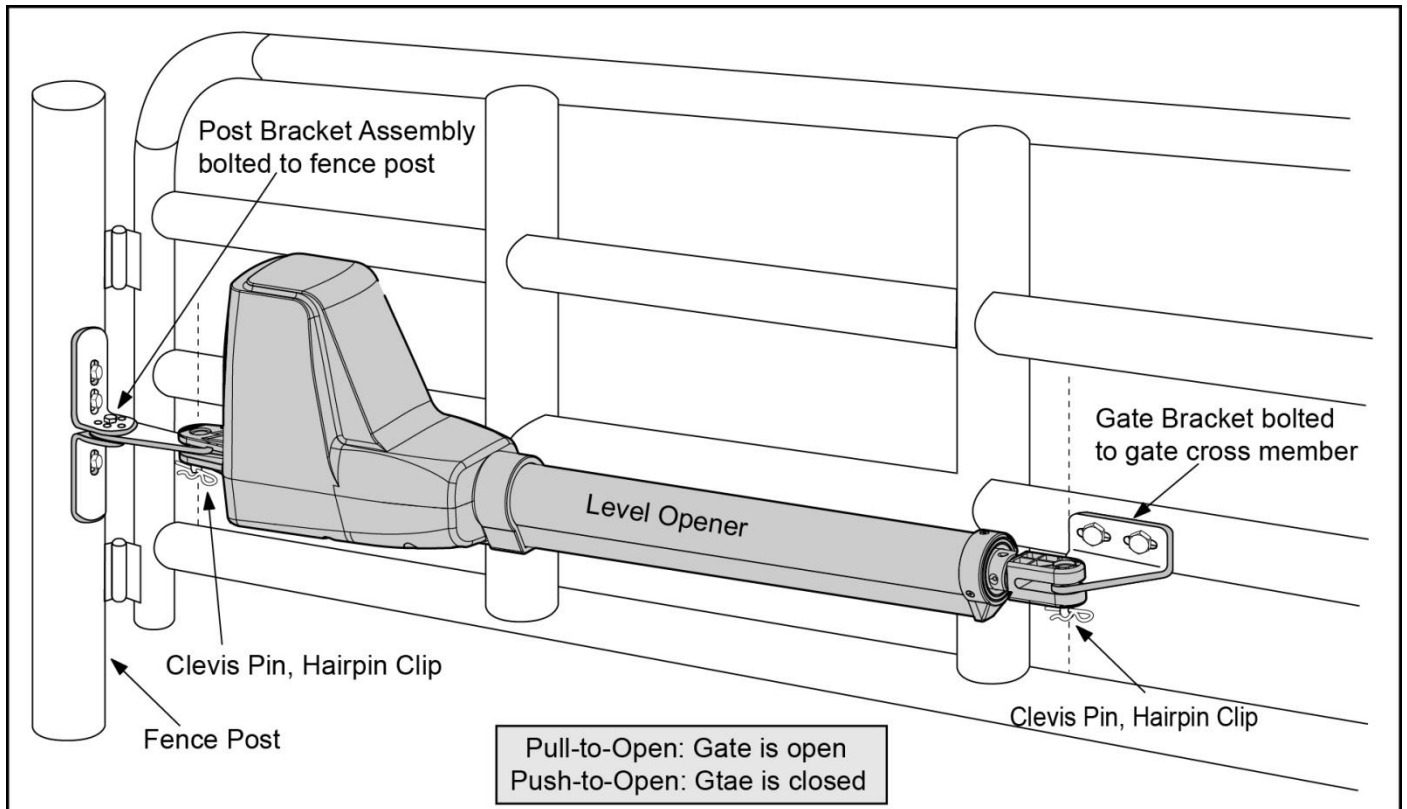

12. Open the release hole plug on the top of the gate opener, insert the release key, and turn the key 90° counterclockwise. This restores normal operation.

Mounting the Control Box

Step 1

To install the control box use the deck screws (not provided). Even though the control box is waterproof designed, for safety reason and a longer service life, it is recommended to install the control box inside a secure surface and at least 100 cm (40 inches) above the ground to avoid being flooded or buried under snow.

Fix control box to a secure surface by using mounting holes and screws (not provided).



Step 2

Insert the power cable and cable of the motor1 through the front strain relief and into the control box by loosening the strain relief screw located in the leftmost of outside bottom of the control box and feeding the cables into the control box. Check the length of cables is long enough to their respective terminal block in control box.

Strain Relief	
	Lock Nut
	Hub
	Sealing Nut

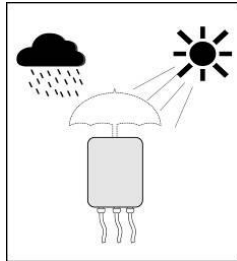

CAUTION: Install the Control Box in a well ventilated place protected against rain and sunlight.



Step 3

Insert the cable of the motor2 and alarm lamp cables into the control box through middle strain relief. Then repeat step 2.

Step 4

Insert other cables into the control box through rightmost strain relief. Then repeat step 2.

NOTE: Only motor cables (1.5m length) are provided. Other cables are subject to site installation requirement and not provided.

CAUTION: Make sure the cable outlet hole in the Control Box is always down during installation so as to drain off the water.

Connection of the Power Supply

⚠ WARNING: NEVER connect the gate opener to the power outlet before all the installations have been done.

The live line and the neutral line should be connected to the power input terminals as the below photo. No matter the polarity.

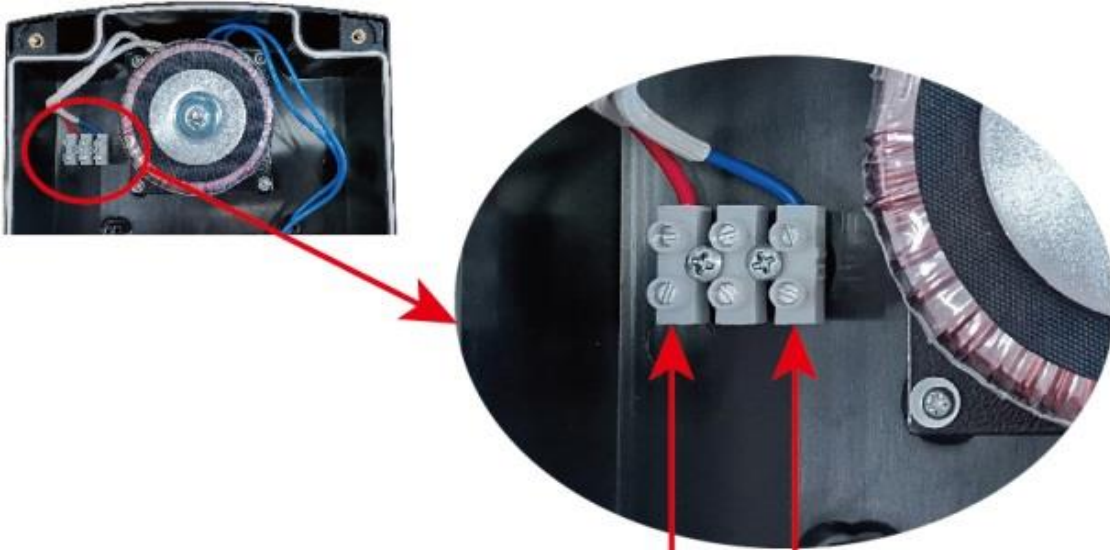

AC main power input

(L, N of the AC electricity can be wired to the No.1 and NO.3 terminals.
No matter the polarity.)

Connecting of the Control Board

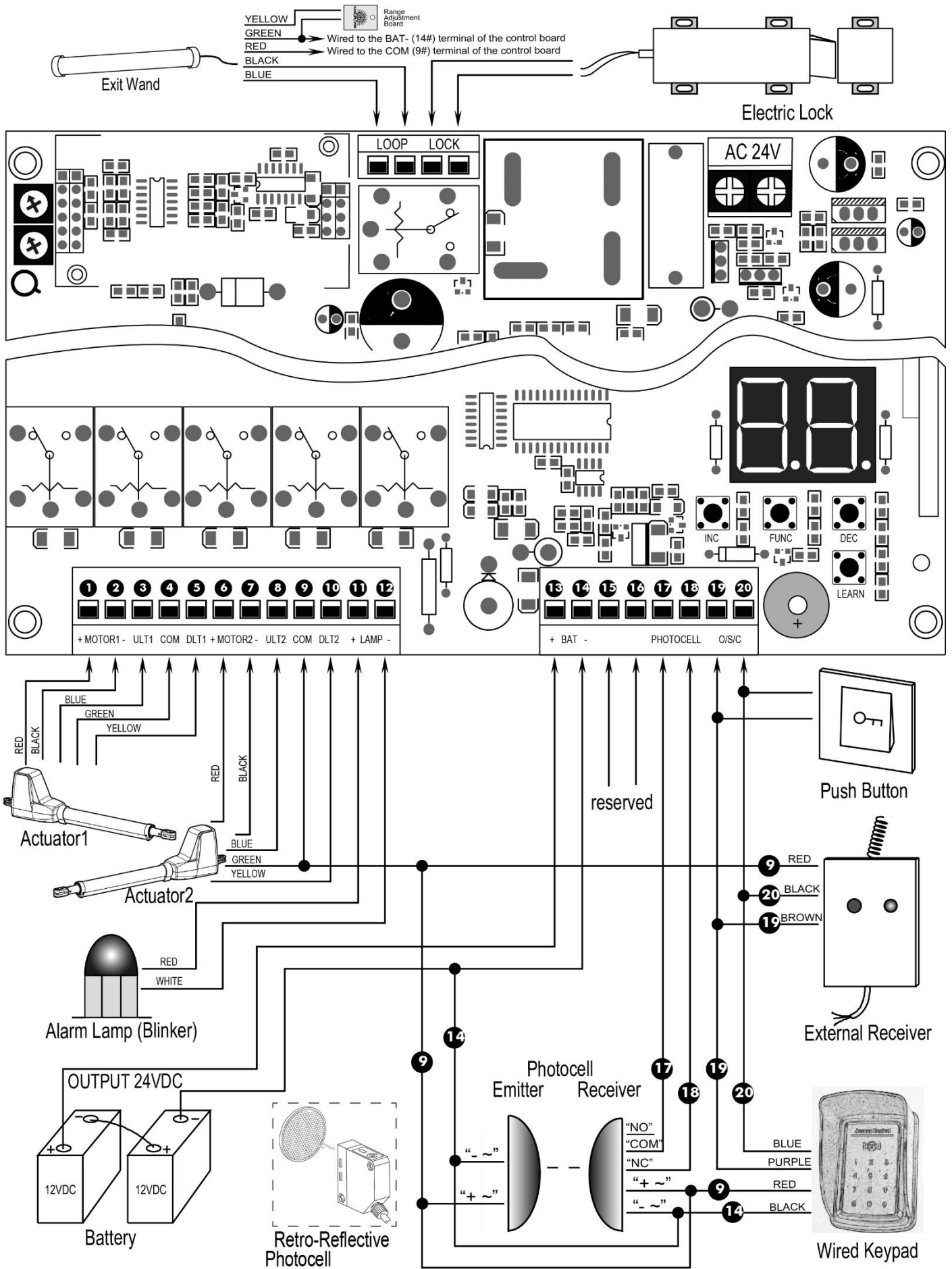

Motor connection for PUSH-TO-OPEN

The motors' power wires and limit wires connection by "Push to Open" is different from the connection by "Pull to Open". So motor 1 and motor 2 wires should be connected to the control box as the instruction on the right. The **black** wire should be inserted into the Motor+ terminal, the **red** wire should be inserted into the Motor- terminal, the **yellow** wire into ULT1 terminal, the **blue** wire into DLT1 terminal and the **green** wire is still into COM terminal.

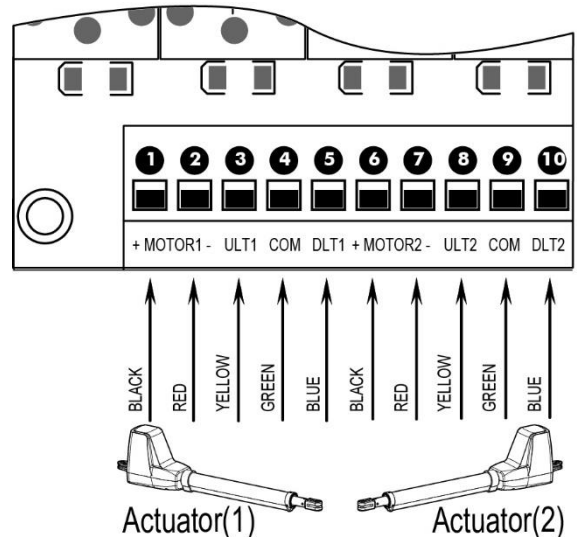

Actuator 1

Insert the stripped cable wires into the appropriate terminals on the opener terminals block. The **red** wire should be inserted into the "MOTOR1+" terminal, the **black** wire into "MOTOR1-", the **blue** wire into ULT1, the **green** wire into COM, and the **yellow** wire into DLT1 terminal.

Actuator 2

Similar as the connection of **Actuator 1**, insert the stripped cable wires into the appropriate terminals on the opener terminals block. The **red** wire should be inserted into the MOTOR2+ terminal, the **black** wire into MOTOR2-, the **blue** wire into ULT2, the **green** wire into COM, and the **yellow** wire into DLT2 terminal.

NOTE: It is recommended that Gate Opener 1 is installed in the Master Gate, and Gate Opener 2 is installed in the Slave Gate.

Alarm Lamp (Blinker) (Included in some models, refers to the actual package)

The red wire of the alarm lamp should be inserted into either **LAMP (#11)** terminal, the white wire into the other one (#12).

Back-up Battery (optional)

The "24V+" of the battery should be wired to the **BAT+ (#13)** terminal, "24V-" should be wired to "BAT-" (#14) terminal.

Photocell Beam System (PBS)

(Included in some models, refers to the actual package)

Use a 2-core cable to connect the "- ~" terminal of the photocell's emitter to the "14" terminal, the "+ ~" terminal to the "9" terminal. Also the "- ~" and "+ ~" terminals of the photocell's receiver should be connected to the "14" and "9" terminals in parallel.

Use another 2-core cable to connect the "COM" terminal of the receiver to the "17" terminal, the "NC" terminal to the "18" terminal.

Push Button (optional)

The push button should be wired to the "19" and "20" terminals. The gate operator works alternately by pushing the button (open-stop-close-stop-open).

Exit Wand (optional)

Please note that the adapter board of the exit wand should be inserted into the main control board of the gate opener before using.

The **BLACK** and the **BLUE** wire of the exit wand should be connected into the “LOOP” terminal, no matter the polarity.

The **RED** wire of the exit wand should be connected into the COM (9#) terminal.

The **GREEN** wire of the exit wand should be connected into the BAT- (14#) terminal.

The sensitivity adjustment board should be wired to the **GREEN** wire and the **YELLOW** wire of the wand. No matter the polarity.

Electric Lock (optional)

The electric lock should be wired to the “**LOCK**” terminal, no matter the polarity of the wires. The E-Plus board is not needed to use with this model of gate opener. Please remove the board from the lock before using.

External Receiver (optional)

The **BROWN** wire of the external receiver should be connected into the “19” terminal.

The **BLACK** wire of the external receiver should be connected into the “20” terminal.

The **RED** wire of the external receiver should be connected into the “9” terminal.

Wired Keypad (24VDC) (optional)

The **RED** wire of the wired keypad should be connected into the “9” terminal.

The **BLACK** wire of the wired keypad should be connected into the “14” terminal.

The **PURPLE** wire of the wired keypad should be connected into the “19” terminal.

The **BLUE** wire of the wired keypad should be connected into the “20” terminal.

Solar Panel (optional)

Please refer to the manual instruction of solar panel and controller separated.

How to Program or Erase the Remote

- ✧ *The remote **MUST** be programed to the opener **BEFORE OPERATING**. Please follow the steps to program the remote.*
- ✧ *Activate the opener only when gate is in full view, free of obstruction and properly adjusted. No one should enter or leave gate area while gate is in motion. **DO NOT ALLOW CHILDREN to operate push button or remote. DO NOT ALLOW CHILDREN TO PLAY NEAR THE GATE.***
- ✧ *If you purchase additional remote controls, the gate opener must be programmed to accept the new remote code.*
- ✧ *If you lose one of any remote control, please erase and reprogram all other remote controls to have a new code for safety.*

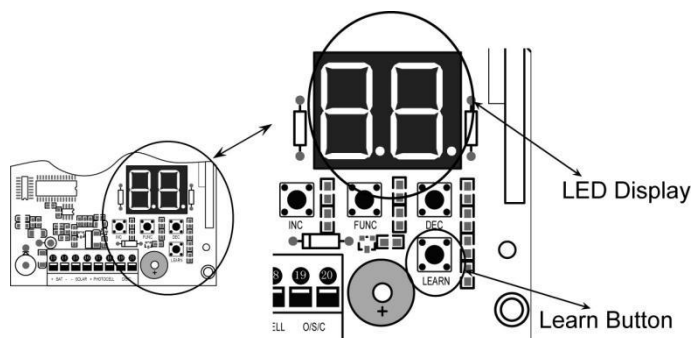

Program the remote

Press and release the learn button, the **LED** will display “Ln”, then press the key in the remote twice in 2 seconds, the **LED** will flash “Ln” for 4 seconds then back to “- -”. Now the remote has been programed successfully.

Erase all the remote codes

Press and hold the learn button until the LED display “dL”, release the button and the LED will be back to “- -”. Now all remote codes have been erased.

NOTE: Max. 8 remotes can be programmed for the opener. An External Receiver (optional) allows up to 250pcs remotes to be programmed for the opener. The external receiver is also compatible with other brand swing gate opener, sliding gate opener and garage door opener.

How to Use the Remote to Operate Your Gate Opener

Each remote has four buttons; they are button A, B, C and D.

You may use this remote to operate as many as 4 sets swing gate openers or 1 set sliding gate opener and 2 sets swing gate openers.

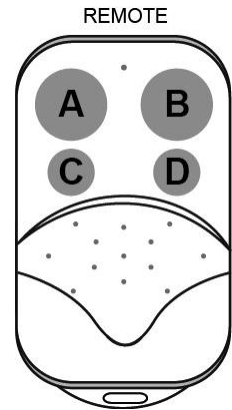

1. Use this remote to only operate swing gate opener

A, B, C and D four buttons share same function once they are programmed with swing gate opener. You may choose any button to program it with our swing gate opener. Every press of the button is able to activate the gate opener to work alternately (open-stop-close-stop-open).

2. Use one remote to operate swing gate opener & sliding gate opener at the same time

All of sliding gate opener have midway mode. Button B is designed to realize midway function (refer to more details in our sliding gate opener manual). So it is must program button A with sliding gate opener, while you may program either C button or D button with swing gate opener.

Wireless Keypad Programming

You can follow the below steps to program wireless keypad to the opener. Press the **LEARN** button until the LED display “Ln”, and then release the button. Then press "OK" button on keypad and LED will flash “Ln” for 3 seconds and then back to “- -” which indicates the keypad has been programmed successfully. You can use the default password “888888” to operate the opener after programming. You can press “PIN” “8 8 8 8 8 8” and then press “OK” to confirm to operate the opener.

Also you can change the password of the keypad follow the below steps. Press “PIN” and then input the six digits old password and then press “PIN” again, the LED will display “CH”. Input the six digits new password and then press the “PIN” to confirm the new setting, LED will flash “CH” for 3 seconds and then back to “- -” which indicates the password has been changed successfully. You can press “PIN” “6 digits new password” and then press “OK” to confirm to operate the opener.

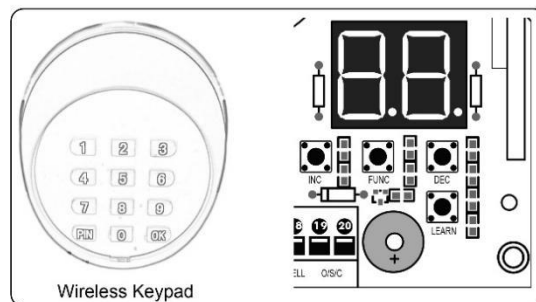

NOTE: Every step for pressing button during program must be finished within 1 second to ensure successful programming.

Setting of the Control Board

⚠ WARNING: Ensure the gate opener is Power Off when you make any adjustment of the gate opener. Keep away from the path of the gate during you set the gate opener system in case of the unexpected gate moving. Carefully adjust settings to avoid the risk of machine damage and injury or death. Always ask the help of professional technician /electrician if you have any question.

1. Check again for completed and correct assembly of your swing gate opener and gate. Plug the Power Cord into the nearest AC outlet. The Digital Display on the Control Board will flash with “- -”. The unit is in standby.

2. Single/Dual Gate Set

Press and hold the “FUNC” button for more than 4 seconds. The Digital Display will indicate “P1”. Gate opener is on the SINGLE/DUAL Gate setting. Press the “INC” and “DEC” buttons respectively to following modes:

“01” shown in Digital Display, it is Single Actuator 1 (Gate 1) mode. “10” shown in Digital Display, it is Single Actuator 2 (Gate 2) mode. “11” shown in Digital Display, it is Dual actuator mode.

Press the “FUNC” button to store the data when the single or dual gate is chosen. The Digital Display will indicate “P2”. Now single/dual gate set is finished.

(Factory set is “11”)

3. Master/Slave Gate Set

When Digital Display indicates “P2”, the gate opener is on the Master/Slave Gate Setting. Press the “INC” and “DEC” Buttons respectively to follow modes:

“01” shown in Digital Display, which means Gate Opener 1 (right-hand side) as Master one

“10” shown in Digital Display, which means Gate Opener 2 (left-hand side) as Master one

Press the “FUNC” button to store the data when the master/slave gate is chosen. The Digital Display will indicate “P3”. Now Master/Slave Gate Set is finished.

(Factory set is “01”)

4. Set the Open Interval between Master and Slave Gate

When the Digital Display indicates “P3”, the gate opener is on the Open Interval between Master/Slave Gate Setting.

The open interval can be adjusted by pressing the “INC” and “DEC” Buttons respectively. The Digital Display will show “0”-“9”, which indicates the interval time “0” means the Master and Slave gates open simultaneously. “1” means the Master Gate starts to open 1 second before Slave gate starts to open. Max. open interval is 9 seconds. Each time you press and release the “INC” button, the figure increases by 1, and the Master gate starts to open 1 more second earlier. Each time you press and release the “DEC” button, the figure decreases by 1, and the interval decreases by 1 second.

(Factory set is 3 seconds)

Press the “FUNC” button to store the data when the open interval is set. The Digital Display will indicate “P4”. Now Open Interval Set is finished.

5. Set the Close Interval between Master and Slave Gate

When the Digital Display indicates “P4”, the gate opener is on the Close Interval between Master/Slave Gate Setting.

The close interval can be adjusted by pressing the “INC” and “DEC” buttons respectively. The Digital Display will show “0”-“9”, which indicates the interval time “0” means the Master and Slave gates close simultaneously. “1” means the Slave Gate starts to close 1 second before Master gate starts to close. Maximum close interval is 9 seconds. Each time you press and release the “INC” button, the figure increases by 1, and the Slave gate starts to close 1 more second earlier. Each time you press and release the “DEC” button, the figure decreases by 1, and the interval decreases by 1 second.

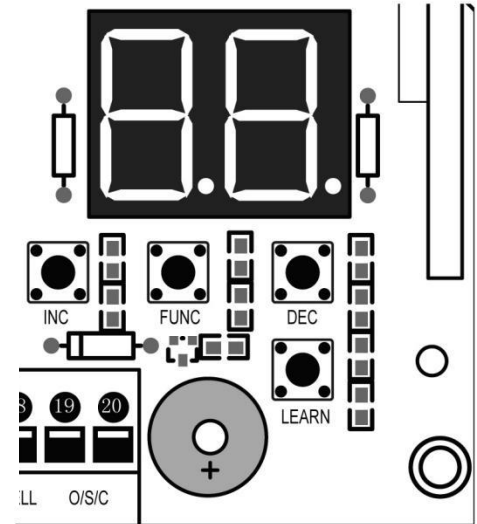

(Factory set is 3 seconds)

Press the "FUNC" button to store the data when the close interval is set. The Digital Display will indicate "P5". Now Close Interval Set is finished.

6. Adjust the Obstruction Sensitivity/Stall Force

When the Digital Display indicates "P5", the gate opener is on the Stall Force Adjustment.

Without a properly installed safety reversal system, person (particularly small children) could be SERIOUSLY INJURED or KILLED by a closing gate.

*Too much force on gate will interfere with proper operation of safety reversal system.

*NEVER increase force beyond minimum amount required to close gate.

*NEVER use force adjustments to compensate for a binding or sticking gate.

* If one control (force or travel limits) is adjusted, the other control may also need adjustment.

* After ANY adjustments are made, the safety reversal system MUST be tested. Gate MUST BE TESTED. Gate MUST reverse on contact with a rigid object.

The opener is equipped with an obstruction sensing feature. If the gate encounters an obstruction the opener will automatically reverse direction and stop. Based on the length and weight of the gate it may be necessary to make force adjustments. The force adjustment should be high enough that small objects such as branches or wind will not cause nuisance interruptions but low enough to prevent serious injury to a person or a vehicle.

6-a Adjust Stall Force of Gate Opener 1

Now we adjust the stall force of gate 1

The stall force of gate opener1 is adjusted by pressing "INC" and "DEC" buttons respectively. The Digital Display will show "1"- "9" which indicates the stall force levels. "1" means the minimum force, and "9" is the maximum force. Each time you press and release the "INC" button, the figure increase by 1, and the force increases to a higher level. Each time you press and release the "DEC" button, the figure decreases by 1, and the force decreases to a lower level. Press "FUNC" to store the data. The Digital Display will indicate "P6". Now stall force of gate opener 1 is finished.

(Factory set is Level 3)

6-b Adjust Stall Force of Gate Opener 2

When the Digital Display indicates "P6".you can adjust force of gate opener 2.

Please perform the same procedure as gate opener 1 (6-a).

Press the "FUNC" button to store the data when stall force of gate opener 2 is set. Then "P7" will be shown on the Digital Display.

NOTE: You may need to increase the stall force in cold weather due to increased resistance from gate hinges. The gate opener's opening/closing force is adjusted automatically according to stall force adjustment.

7. Adjust the Max Motor Running Time (MRT) of the MOTOR for gate opener

The maximum running time of the MOTOR can be set to make the motor stop running after a specified period even if the limit switch is invalid or the clutch is detached.

7-a. Adjust the MRT of MOTOR1

When the Digital Display indicates "P7", you can adjust the MRT of MOTOR1.

The MRT of MOTOR1 is adjusted by pressing "INC" and "DEC" buttons respectively. The Digital Display will show "01"- "50" which indicates the MRT of MOTOR1 from 1 to 50 seconds.

You can hold pressing the "INC" or "DEC" button for more than 1 second to speed up the setting. Press the "FUNC" button to store the data when you finish setting. The Digital Display will indicate "P8".

(Factory default setting is "40" seconds)

7-b. Adjust the MRT of MOTOR2

When the Digital Display indicates "P8", you can adjust the MRT of MOTOR2.

Please perform the same procedure as adjusting MOTOR1 (7-a).

Press the “FUNC” button to store the data when you finish setting. The Digital Display will indicate “P9”. Now MOTOR2 adjustment is finished.

8. Set the Safety Photocell Beam System (PBS) (Optional)

When the Digital Display indicates “P9”, the gate opener enters PBS set mode.

You can press and release the “INC” or “DEC” button to set or shut off the PBS function. The Digital Display indicates “11”, the PBS is available. The Digital Display indicates “00”, the PBS is null.

Note: If the “11” is be set, the gate opener won’t work until the PBS system is equipped. The PBS system works only when gate opener is closing. The gate opener will return to its open position when the obstruction blocks the beam from photo eye.

Press the “FUNC” button to store the data when the PBS is set. The Digital Display will indicate “PA”.

(Factory set is “00”)

9. Set the Automatic Closing Time

When the Digital Display indicates “PA”, the gate opener enters into the setting of automatic closing time mode. Press and release the “INC” or “DEC” button, the Digital Display will show a “01”-“99” which indicates the current automatic closing time. The minimum time is 1 second, 99 seconds maximum. Each time you press and release the “INC” button, the figure increases by 1, and the timing increases by 1 second. Each time you press and release the “DEC” button, the figure decreases by 1, and the timing decreases by 1 second. When the timing is “00”, the automatic closing function is shut off and the gate will stay open.

(Factory set is 60 seconds)

Press the “FUNC” button to store the data when the desired automatic closing time is set. The Digital Display will indicate “Pb”

10. Set the Period of Soft Start

When the Digital Display indicates “Pb”, the gate opener is ready for setting period of soft start.

You can press the “INC” or “DEC” button to set the period of soft start. There is 1-9 seconds available in setting. Press the “FUNC” button to store the data when the period is set. The Digital Display will indicate “PC”.

(Factory set is 3 seconds)

11. Set the Fast Running Period (FRP) to Achieve Soft Stop Function (SPP)

When the Digital Display indicates “PC”, the Fast Running Period for opening or closing gate is adjustable by pressing “INC” and “DEC” buttons respectively, and the Soft Stop Function is achieved simultaneously.

The Soft Stop means the gate opener runs at slow speed during the last period before the gate completely closes.

The Soft Stop Period is unavailable by direct adjust but available through adjusting the Fast Running Period.

There are two running speeds designed in program, i.e. Fast Running Speed and Soft Running Speed. The Fast Running Period is adjustable from 1 to 28 sec. Factory default setting is 15 sec.

Since the GATE OPENING OR CLOSING RUNNING PERIOD (GRP) = SOFT START PERIOD (STP) + FAST RUNNING PERIOD (FRP) + SOFT STOP PERIOD (SPP), the SPP could be extended by shortening the FRP when the GRP and STP are fixed. In other words, $SPP = GRP - STP - FRP$.

Similarly, the Soft Stop Period (SPP) can be shortened through extending the Fast Running Period (FRP).

E.g. When the Soft Start Period (STP) is set at 3 sec, and the GRP is 23 sec, how can we get 4 sec of Soft Stop Period (SPP) to meet the requirement? The answer is clear, i.e. we may set the Fast Running Period (FRP) at 16 sec ($23 - 3 - 4 = 16$ sec).

12. Return to Factory Set

When the Digital Display indicates “Pd”, press and release the “INC” or “DEC” button. All data will return to factory set, the Digital Display indicates “dF”.

1. If all of data is set and no other change needed, press “FUNC” Button. “- -” appears on the Digital Display, and the opener enters standby mode.

Indicate Illustration on the Digital Display When Gate Opener is Running

The left image on Digital Display symbolizes motor of gate opener **2** when the gate opener is running. The right image on Digital Display symbolizes motor of gate opener **1**.

When the motor is run to gate -open direction or gate -close direction, the image on Digital Display indicates “n” or “u” respectively.

When the motor is not running, the Digital Display indicates “- -”.

Adjusting the Limit Switch

Adjusting the Limit Switch of Actuator 1

The position of Limit Switch A was fixed in factory, do not adjust it again.

Plug on the power to running gate opener, use a screwdriver to loosen the screw of Limit Switch B, slide Limit Switch B to the desired closed position and fix it.

Limit setting for Gate 1 is finished now.

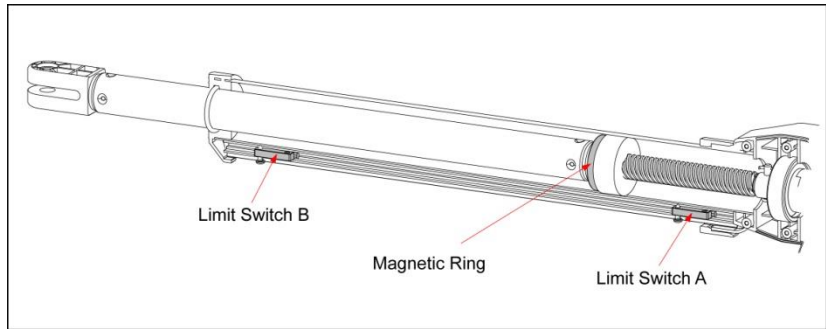

NOTE: Always place the magnetic ring between the Limit Switch A and B.

Adjusting the Limit Switch of Actuator 2

The position of Limit Switch C was fixed in factory, do not adjust it again.

Use a screwdriver to loosen the screw of Limit Switch D, slide Limit Switch D to the desired closed position and fix it.

Limit setting for Gate 2 is finished.

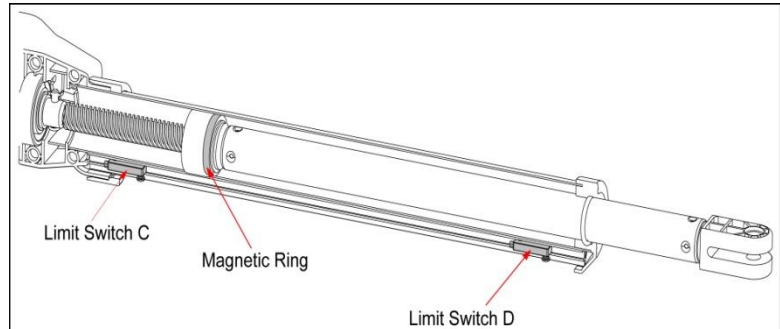

NOTE: Always place the magnetic ring between the Limit Switch C and D.

NOTE: The magnetic ring in the moving rod can be manually placed between both Limit Switches in each actuator by releasing the clutch.

Maintenance

Warning: Disconnect power before servicing.

1. Using a clean, dry cloth to wipe the gate opener shaft, and then apply a silicone spray to reduce its friction. In cold climates where temperatures reach 1°C (30°F) or less, spray silicone on the actuator every 4~6 weeks to prevent freeze up.
2. Regularly check gate hinges to make sure gate is swinging smoothly and freely. Grease hinges if needed.
3. Check your installation periodically, as hardware and posts will shift. Brackets may need to be adjusted or hardware may need to be tightened.
4. Maintain the area around your gate. Keep the areas free of objects that can prevent the gate swinging freely.

NOTES:

1. Inspection and service should always be performed anytime a malfunction is observed or suspected.

- 2. It is suggested that while at the site voltage readings be taken at the operator. Using a Digital Voltmeter, verify that the incoming voltage to the opener it is within ten percent of the opener's rating.*
- 3. Refer to the instructions on how to check gate force and sensitivity adjustments.*

Trouble Shooting

◆Opener does not run. Digital Display indicator is not on.

1. Check if the power is on. Check the input voltage at the terminal. It should be local AC power. If the voltage measures 0 using the voltmeter, the power cable may be damaged.
2. Check if the output voltage of the transformer is 24Volts AC. If the voltage measures 0, the transformer may be overheated or damaged. Turn power off and allow transformer to cool for several minutes then reset. Replace the transformer if the symptom still exists.
3. Check the fuse in the control board. Replace the fuse if necessary.

◆Opener powers up but does not run.

1. Check if the arm cable is loosening. Verify that all of the wires of the arm are secure to the terminals of the control board.
2. Arm is incorrectly installed. Disconnect the motor housing from the arm and check if the arm moves freely.
3. Gate is excessively heavy or hinges are bad. Check the gate is within the ratings for this product. Disconnect the arms and verify that both gates swing easily. Lubricate or replace hinges as necessary.
4. Bad control board. Call technical support for help with replacement parts.

◆Gate stops immediately after it starts moving.

1. Obstruction sensed. Check safety devices and gate for obstructions.
2. Force set too low. Adjust FORCE setting until gate completes a full open/close cycle without stop. The force setting may need to be adjusted in cold weather, as the gate will not move freely.
3. Check if the MRT period is too short.

◆Gate opens but does not close.

1. Photocell (PBS) function is enabled in control board setting but is not equipped (optional). Please cancel the PBS setting (P9 set to 00).
2. Obstruction blocking close photo eyes, Check eyes for alignment and verify all connections and operation for safety devices.
3. Remove the BLUE&GREEN&YELLOW wires of the arm from the control board and use a jumper wire to short the ULT&COM&DLT terminals of the control board which for connecting the three wires and then try it again. The limit switch of the arm is faulty if the arm could run normally.

◆Gate ignores the limit switches

1. Check that the wires of the limit switch (BLUE&GREEN&YELLOW wires of the arm) are not shorted.
2. Limit switch of the arm is faulty. Replace the limit switch as necessary.

◆Gate opens, closes or stops on its own

1. Please make sure the wire connection of the arm is according to the installation of "PULL TO OPEN" or "PUSH TO OPEN".

Quick-Setting Guide

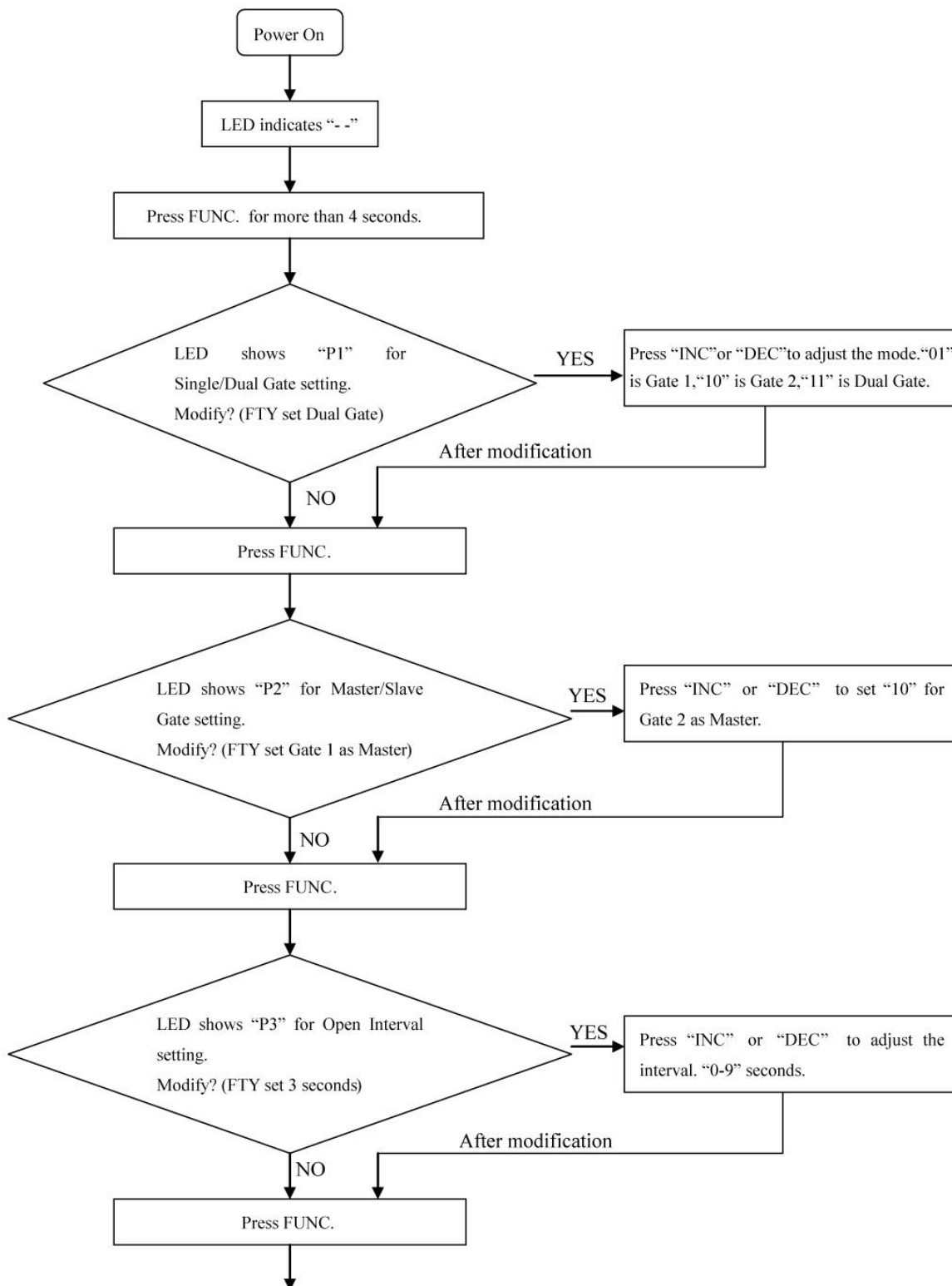

To be continued ...

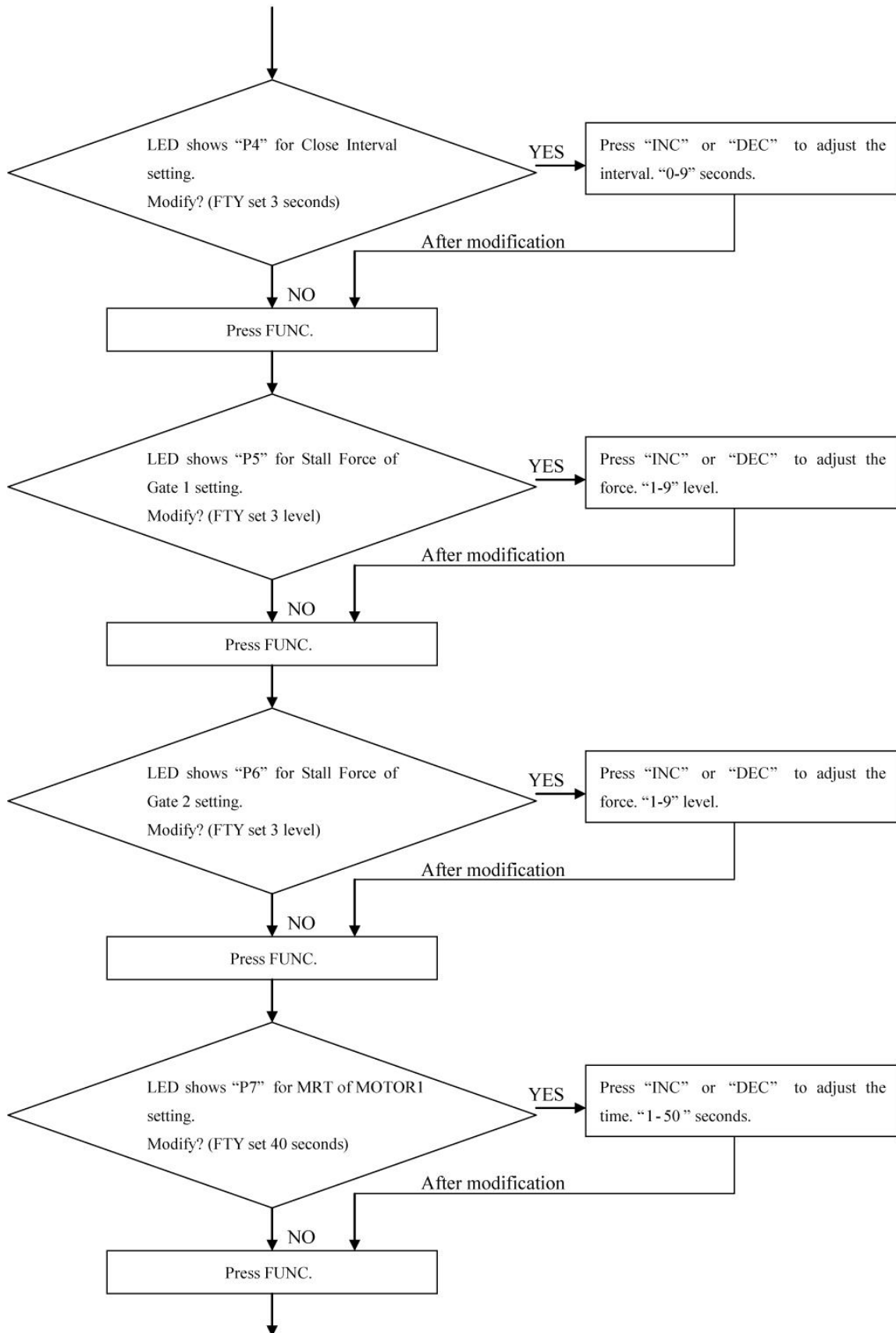

To be continued ...

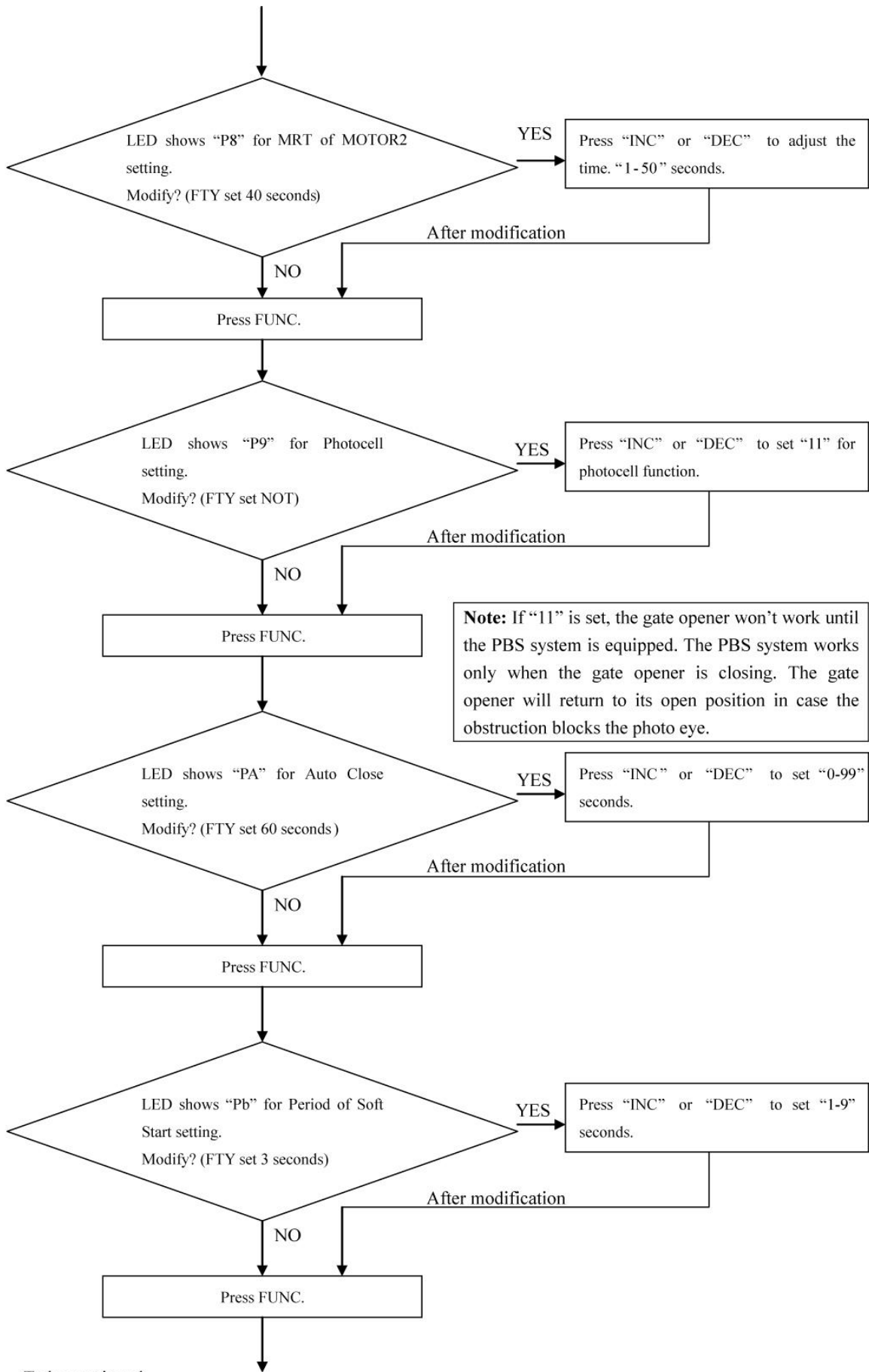

To be continued...

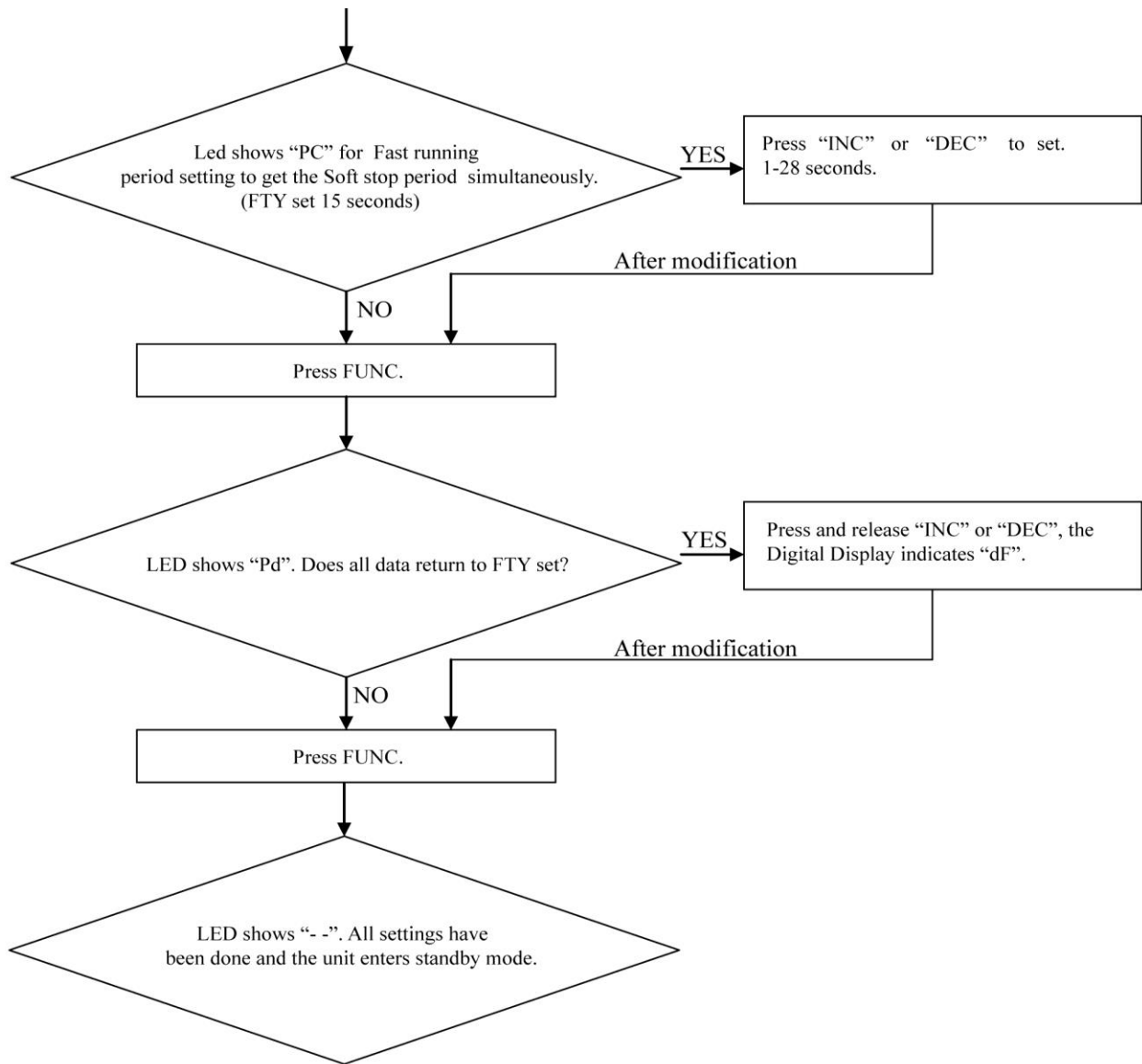

IMPORTANT NOTICE TO USERS:

To maintain the proper working condition of your new automatic gate opener, we recommend that you spray the actuator shaft every 4~6 weeks with silicone. This will keep the actuator working freely and prevent problems.

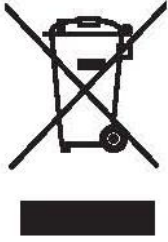

According to Waste of Electrical and Electronic Equipment (WEEE) directive, WEEE should be separately collected and treated. If at any time in future you need to dispose of this product please do NOT dispose of this product with household waste. Please send this product to WEEE collecting points where available.